

# DISHWASHING GUIDE (DU5J)

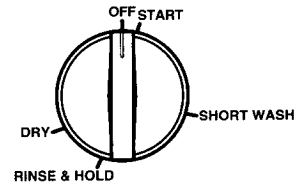
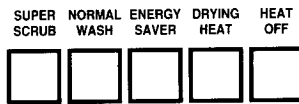

## How to Operate Your New Dishwasher

- STEP 1.** Load the dishwasher according to the instructions on pages 5-7.
- STEP 2.** Add detergent to the detergent dispenser. See page 4. Use rinse aid to help prevent spotting and filming and to improve drying results. See page 5.
- STEP 3.** Select the appropriate cycle. Refer to the chart below for additional information.
- STEP 4.** Select/deselect heating option. Press the door until it latches and start the dishwasher. The cycle will begin with a drain prior to filling.

## CYCLE DESCRIPTIONS

### Super Scrub Cycle

For heavily soiled dishes, pots and pans.  
 Cycle Time: Approx. 66 minutes  
 Water Usage: Approx. 11 gallons

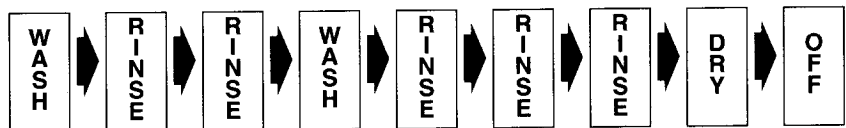

### Normal Wash Cycle

For normally soiled dishes.  
 Cycle Time: Approx. 56 minutes  
 Water Usage: Approx. 9.5 gallons

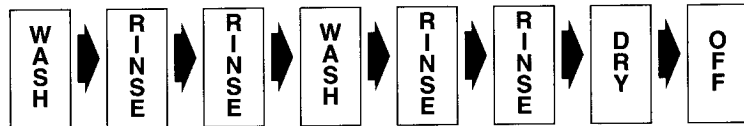

### Energy Saver Cycle

For medium to lightly soiled dishes.  
 Cycle Time: Approx. 56 minutes  
 Water Usage: Approx. 8 gallons

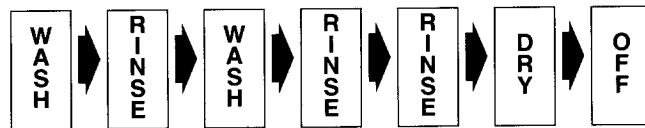

### Short Wash

For turnaround of lightly soiled dishes.  
 Select a Normal Wash Cycle and turn dial to Short Wash.

Cycle Time: Approx. 36 minutes  
 Water Usage: Approx. 4.5 gallons

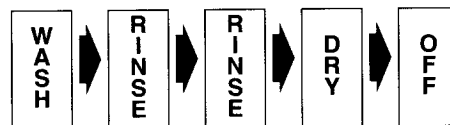

### Rinse & Hold

For rinsing a few dishes until full.  
 Cycle Time: Approx. 13 minutes  
 Water Usage: Approx. 3 gallons

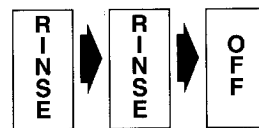

## Heating Options:

**DRYING HEAT.** Available on all cycles except Rinse & Hold. Add 30 minutes to the cycle times listed above.  
**HEAT OFF.** Drying Heat is turned off.

# CONTENTS

Cycle Description .....	1
For Future Reference.....	2
Energy Saving Tips .....	2
Safety Instructions.....	3
Using Your Dishwasher .....	4
Hot Water .....	4
Detergent.....	4
Rinse Aid .....	5
Preparing the Dishes.....	5
Loading the Dishwasher .....	5-7
Convertible Dishwasher Connection .....	7
What Can and Cannot be Washed.....	8
Care and Cleaning.....	9
Storing Your Dishwasher .....	9
Changing Color Panels.....	9
The Problem Solver .....	10-12
If You Need Service.....	12
Warranty.....	13

## FOR FUTURE REFERENCE. . .

Before operating your dishwasher, please read this book carefully. It is designed to help you operate and maintain your new dishwasher properly. Keep it handy for answers to your questions.

Write your model and serial numbers in the spaces provided below. You'll find them on the data label located on the upper left corner of the door frame.

Use this information for any correspondence or service calls concerning your dishwasher.

Model Number
--------------

Serial Number
---------------

Date of Purchase
------------------

**WARNING - To avoid possible electrical shock, check with the installer to make sure the appliance has been properly grounded. In addition, be sure to read the IMPORTANT PERSONAL SAFETY INSTRUCTIONS on page 3 before starting to use this dishwasher.**

## ENERGY SAVING TIPS

- Operate the dishwasher only when it's full. Running a half-full dishwasher uses the same amount of electricity and hot water as a full dishwasher.
- Always select the shortest cycle possible for the amount of food soil. See page 1.
- Load correctly for best results. See pages 5-7.
- Use your dishwasher during off-peak hours. Ask your local utility company for off-peak rates.

---

# IMPORTANT PERSONAL SAFETY INSTRUCTIONS

Products with a  label have been listed with the Underwriters' Laboratories, Inc.—those with a CSA tag have been listed with Canadian Standards Association. Nevertheless, as with any other equipment using electricity and moving parts, there is a potential hazard. When using your dishwasher, follow basic precautions, including the following:

1. Read all instructions before using the dishwasher.
2. Use the dishwasher only for its intended function.
3. Disconnect electrical power to dishwasher before attempting to service.
4. To avoid electrical shock hazard, the sides and back must be enclosed, and the front panels must be attached before electrical power is applied to the dishwasher. Refer to the installation instructions for proper grounding procedures.
5. Connect to a properly rated, protected and sized power supply circuit to avoid electrical overload.
6. Children should never be permitted to operate, or play in, with, or around this dishwasher.
7. To reduce the risk of injury when loading items to be washed, sharp or pointed items should be located with the handles up. Also, load sharp items so they are not likely to damage the door seal.
8. Be careful not to touch the heating element on the bottom of the tub during or at the completion of a cycle. It may be hot.
9. Use only detergents and rinse additives designed for an automatic dishwasher. Never use soap, laundry detergent, or hand washing detergent in your dishwasher. Keep these products out of the reach of children.
10. Do not sit, stand on or abuse the door or dish racks of the dishwasher.
11. Under certain conditions, hydrogen gas may be produced in a hot water system that has not been used for two weeks or more. **Hydrogen gas is explosive.** If the hot water system has not been used for such a period, turn on all hot water faucets and let the water flow from each for several minutes. This will release any accumulated hydrogen gas. As the gas is flammable, do not smoke or use an open flame during this process.
12. Do not wash plastic items unless marked "dishwasher safe" or the equivalent. For plastic items not so marked, check the manufacturer's recommendations.
13. Do not tamper with controls.
14. Always remove the door to the washing compartment when removing an old dishwasher from service or discarding it.

**SAVE THESE INSTRUCTIONS**

# USING YOUR DISHWASHER

## Hot Water

For proper performance, hot water is necessary. For best cleaning and drying results, set your water heater to deliver 140°F (60°C) water to the dishwasher. If, for any reason, the temperature of the water entering the dishwasher is below 140°F, select the option (if available) to have your dishwasher heat the water.

To check water temperature, turn on the hot water faucet nearest the dishwasher. Let the water run into a glass until it is as hot as possible, then check with a candy or meat thermometer. If the temperature at the faucet is below 140°F, have a qualified person raise the water heater thermostat setting.

Helpful hints:

- If outside temperatures are unusually low, or if your water travels a long distance from the water heater to the dishwasher, you may need to increase your water heater's thermostat.
- If you have not used hot water for some time, the water in the pipes will be cold. Turn on the hot water faucet at the sink and allow it to run until the water is hot. Then start the dishwasher.
- If you've recently done laundry or run hot water for showers, give your water heater time to recover before operating the dishwasher.

## Detergent

Use only powder or liquid detergents specifically made for use in automatic dishwashers. Other types (laundry, hand soap, etc.) will cause oversudsing. Use

fresh detergent and store it in a cool, dry place (not under the kitchen sink).

## Amount to Use

The amount of detergent to use depends on the water hardness (measured in grains per gallon-gpg) and the amount of soil on the dishes. Generally detergent amounts should be increased for harder water and heavier soil.

A basic guideline is one teaspoon of detergent for each grain of water hardness (gpg). Use a minimum of three teaspoons (one tablespoon) in soft water.\*

If the water hardness is 15 grains or harder, it will be virtually impossible to get good results with any dishwasher. The only solution is a mechanical water softener to improve water quality.

## Adding Detergent

There are two detergent dispensers on the inside door of your dishwasher. Longer cycles have two washes and need detergent in both cups, while shorter cycles have only one wash and need detergent placed in the covered cup.

After adding detergent to the Main Wash cup always snap the lid closed. Detergent placed in the Pre-Wash cup (open cup) will be dispensed immediately.

Refer to the Detergent Usage Guide below for detergent amounts and placement for each cycle. Your dishwasher may not feature all the cycles listed.

## Detergent Usage Guide (powder or liquid)

CYCLES	SOFT WATER (0-3 grains hardness)		MEDIUM WATER (3-7 grains)		HARD WATER (7-12 grains)	
	Main Cup	Open Cup	Main Cup	Open Cup	Main Cup	Open Cup
SUPER SCRUB NORMAL WASH ENERGY SAVER CHINA/CRYSTAL	1 Tbsp. minimum	1 Tbsp. minimum	2-3 Tbsp. (2nd Line)	2-3 Tbsp. (2nd Line)	3-4 Tbsp. (3rd Line)	3-4 Tbsp. (3rd Line)
SHORT WASH	1 Tbsp. minimum	None	2-3 Tbsp. (2nd Line)	None	3-4 Tbsp. (3rd Line)	None
RINSE & HOLD	Use no detergent		Use no detergent		Use no detergent	

*\*Note: When using ultra dishwashing detergents, use the amount recommended on the package.*

---

## Rinse Aid

Using a rinse aid makes water flow off the dishes better. This lessens water spotting and filming and improves drying. For best dishwashing performance, using a rinse aid is recommended.

Rinse aids come in either solid or liquid form. When using a solid rinse aid such as Jet Dry, fasten it to the back right corner of the lower rack. Purchase new rinse aid when the solid material dissolves and the container is empty.

When using a liquid form, the rinse aid dispenser (Select Models) automatically releases a measured amount of rinse aid into the final rinse.

To fill, turn the dispenser cap counterclockwise to open. Remove the cap and pour the liquid rinse aid into the opening. Depending on how often the dishwasher is used, it should last about three months. The level of the rinse aid should be checked periodically. An 'E' appearing in the bottom of the reservoir indicates the dispenser is empty and needs to be refilled.

## Preparing the Dishes

If this is your first dishwasher, or if you're replacing a much older model, you may wonder how much preparation your dishes need. Actually very little. Pre-rinsing of normal food soils is not necessary. With common sense and a little practice, you'll soon know what foods to remove. Here are some guidelines:

1. Scrape off bones, skins, toothpicks and other hard or large food solids. Remove excessive quantities of oil or grease.
2. Remove large quantities of any food. Your dishwasher has a built-in soft food disposer that chops soft food bits and flushes them away. It can handle small amounts of soft foods, but large amounts will be difficult to handle. You may hear chopping noises during the cycle. This is normal.
3. For burned-on soil, it may be necessary to pre-soak or lightly scour the item before loading. Remember to use the Rinse & Hold cycle (Select Models) for small "holding" loads.
4. Since certain foods such as mustard, mayonnaise, vinegar, lemon juice and other acidic foods can cause discoloration on stainless steel, it is recommended to rinse these soils off susceptible flatware.

## Loading the Dishwasher

**Helpful Hints:** Always load items on the racks so they are separated and face the center to insure the water spray will reach the soiled surfaces. Do not allow items to extend out of the racks.

Make sure the movement of the upper and lower spray arms is not blocked by items hanging below the lower rack or tall articles in the upper rack. **Do not block the center area of the lower rack.** A center wash tower extends through this area to improve cleaning.

Insure the free flow of water to the detergent cups by not blocking with large items.

On the following pages are illustrations showing various loading possibilities.

## Adding a Forgotten Item:

For best cleaning, the forgotten item(s) should be added early in the cycle.

1. Unlatch the door and wait until the sound of the circulating water stops.
2. Open the door and add the item(s).
3. Pause before latching the door. The cycle will continue at the point it was interrupted.

## Upper Rack

The upper rack is designed to hold glasses, cups, small plates, bowls, etc.

Bowls fit securely in the back right half of the top rack. Small plates, such as salad plates, can be loaded in front of the bowls, facing the center. Glasses and cups of varying sizes can be loaded in the center and left side. If additional space is needed for loading small plates, the center left set of rack tines can also be used.

When loading glassware, leave a small space between each piece so they do not touch each other during the wash cycle. Do not place glasses over the tines. Instead, rest them against the side of the rack or tines.

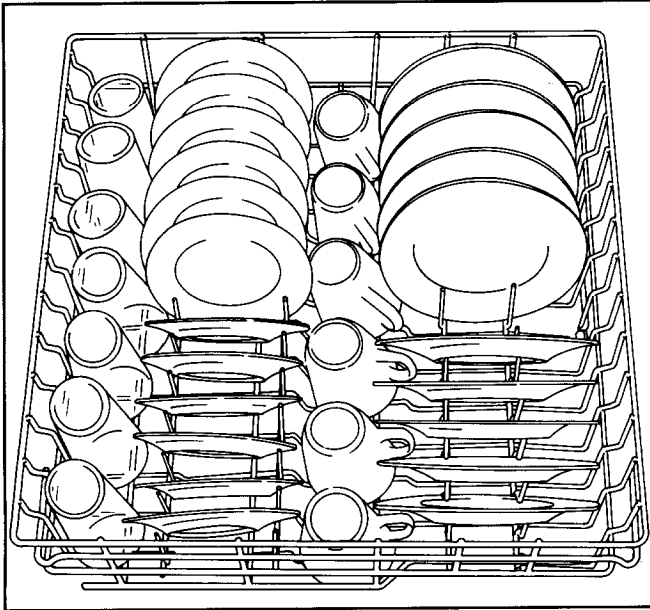

## Lower Rack

Large dinner plates and other dishes may be placed in any convenient location in the lower rack with soiled surfaces facing the center. The back half of the lower rack is designed to accommodate either large dinner plates or two parallel rows of smaller plates. When loading large dinner plates, use the wide tine spacing to center the plates.

The lower rack is also a good place to load large or tall items such as bakeware and serving platters or bowls. The back left side of the lower rack has an area without tines and is suited for wide items (muffin tins, casserole dishes, etc.)

Small items such as plates, saucers or shallow bowls may be loaded in the elevated area behind the wash tower.

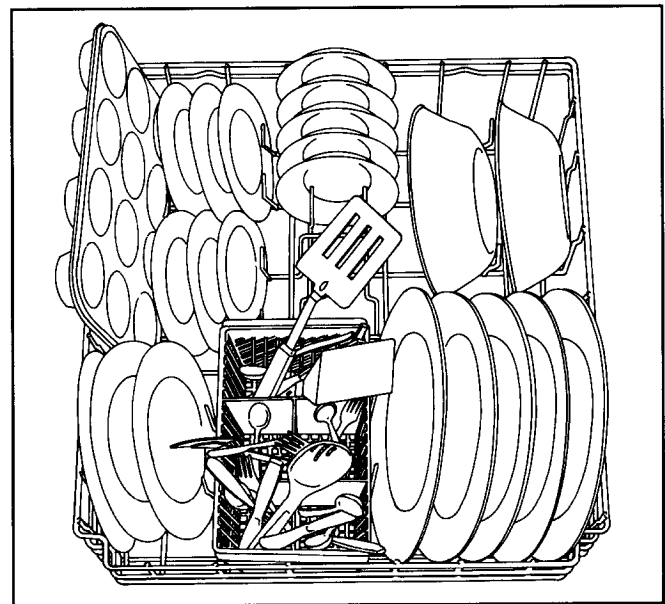
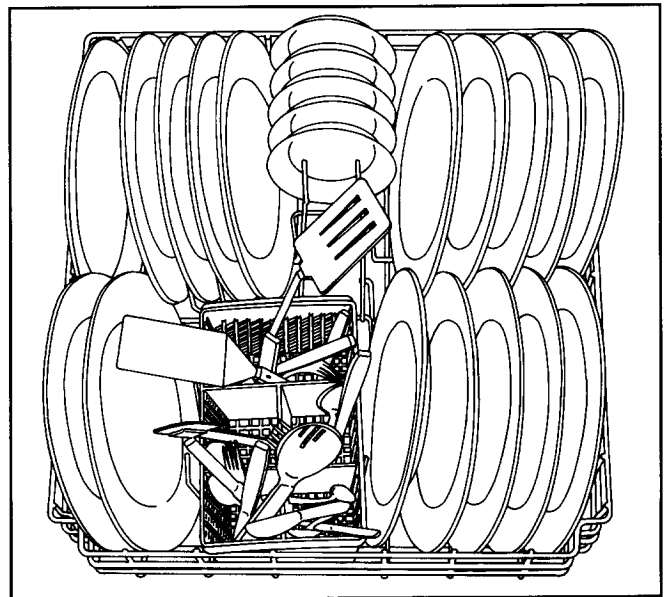

## Utensil Tray (Select Models)

The removable utensil tray sits on top of the upper rack and holds long, awkward items such as spatulas, serving spoons, knives, etc. When using the tray, be sure items do not block the upper wash arm.

## Flatware

Put flatware in the removable silverware basket by mixing knives, forks and spoons. To prevent them from nesting together, place some handles up and some down. However, sharp or pointed items should always be loaded with the handles up.

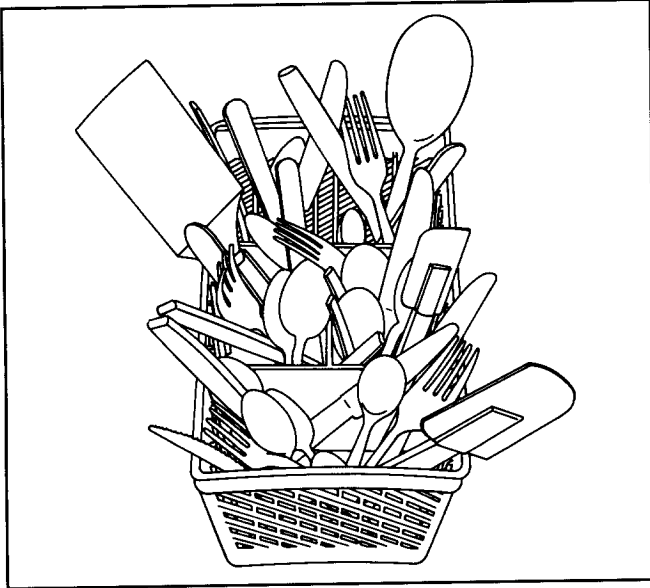

## Convertible Dishwasher Connection

Turn on the hot water faucet and allow the water to run until it is hot. Then, shut off the water faucet.

Pull the faucet connector from the recess in the back of the dishwasher as shown.

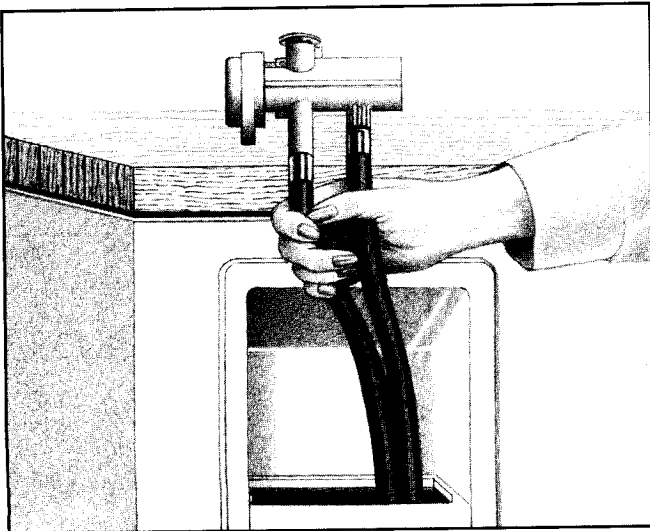

Press down on the thumb release. Lift the connector up onto the faucet and release your thumb pressure so the connector is held firmly in place.

Turn the hot water faucet on full force.

Be sure the sink drain is open so that water from the dishwasher will drain properly.

Pull the electric cord from the back of the dishwasher and plug it into a properly grounded electrical outlet.

Follow the operating suggestions listed on the cover of this book.

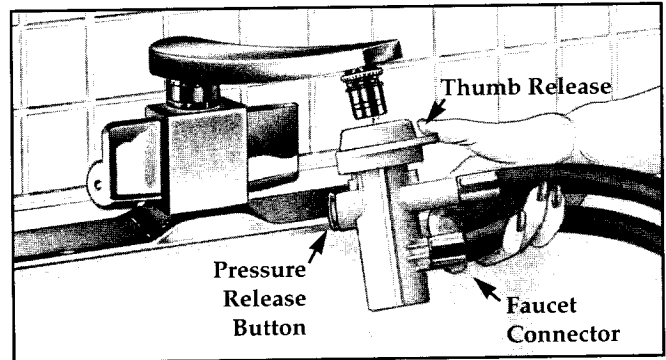

## To disconnect the dishwasher:

Turn the hot water faucet off.

Press the water release button to release any water pressure.

Press down on the thumb release and remove the connector from the faucet.

Replace the connector into the recess on the back of the dishwasher.

# WHAT CAN AND CANNOT BE WASHED

Remember: It is the user's responsibility to determine if the item should be washed in a dishwasher.

<b>Material</b>	<b>Usually Safe</b>	<b>Exceptions (not safe)</b>	<b>Special Instructions</b>
Aluminum	YES	Some colored anodized aluminum can fade.	Some darkening or spotting possible. Remove by scouring with soap-filled steel wool pads.
China/ Stoneware	YES	Antique, metal-trimmed, hand-painted or over-the-glaze patterns fade. Gold leaf will discolor.	If in doubt, check with the manufacturer. Or test wash one piece daily for at least a month. Compare with the rest of the set.
Crystal	YES	Antique, metal-trimmed or hand-painted patterns fade. Gold leaf will discolor.	Load securely to prevent movement. Check manufacturer's instructions for your crystal.
Non-dishware items—such as electronic air cleaner filters, furnace filters, paint brushes, etc.	NO		Do not wash in dishwasher. Damage to dishwasher and discoloration or staining of dishwasher may result.
Glass	YES	Milk Glass may yellow.	
Iron	NO	Iron will rust.	
Pewter	NO	Pewter tarnishes.	
Plastics	YES		If it doesn't say DISHWASHER SAFE, test one piece before dishwashing an entire set.
Stainless steel	YES		Rinse if not washing immediately. Salty or acidic foods can stain if left on.
Sterling Silver and Silver plate	YES	Don't put in same silverware basket with stainless steel. Contact between metals can damage silver. Don't wash copper utensils in the same load. Silver may get a brown film. Adhesive used to attach some hollow-handle knives can loosen.	Rinse if not washing immediately. Salty or acidic foods can stain if left on. Dry detergent can cause difficult-to-remove black spots. Place in back section of silverware basket to avoid exposure to detergent from the detergent cup.
Non-stick coatings	YES		
Tin	NO	Tin can rust.	
Wood	NO	Wood can warp, crack or lose its finish with any type of washing.	



---

## CARE AND CLEANING

Clean the control panel with a lightly dampened cloth. Dry thoroughly. Do not use abrasives or sharp objects on the panel. They can damage it.

To care for a wood top on a convertible dishwasher, first wipe the top with a damp cloth to remove surface dust, then dry. Next, saturate a cloth with mineral oil and apply a heavy coat to the wood top. Let it stand overnight. The next day apply a thin coat of mineral oil and rub with a soft dry cloth. Repeat these steps every few months to maintain the appearance of the wood top.

The inside normally takes care of itself. Occasionally check the tub bottom for any large pieces which may have collected. Periodically clean the bottom edge of the door liner if any spills or food soils are noticed after a cycle.

To remove any odor, try one of the following:

1. Put baking soda in both cups. Select the Normal cycle and let the water circulate for about 10 minutes. Stop the dishwasher by unlatching the door. Let it sit overnight. Then restart the dishwasher by latching the door and letting it complete the cycle.
2. Select the Normal cycle and let the dishwasher fill with water. Then open the door and pour  $\frac{1}{4}$  cup of chlorine bleach into the bottom of the dishwasher. Latch the door and let it complete the cycle.
3. Try using a lemon scent detergent and/or rinse aid to help periodically freshen a dishwasher interior. It is also recommended that you switch detergents if you notice a strong chemical or chlorine odor from your present detergent.
4. Run the dishwasher more frequently. Use the Rinse & Hold cycle (if available) to remove any food soil that may cause an odor.

## STORING YOUR DISHWASHER

If your dishwasher will be in storage or an unheated area exposed to freezing temperatures, please follow these recommendations:

- Clean the dishwasher inside and out as explained in the Care and Cleaning section. (Also clean the door gasket).
- Operate the drain portion twice to ensure most of the water will be removed. Most dishwashers begin

each cycle with a drain for touch control models, press the Drain/Off pad. (See page 1.)

- Disconnect the electrical supply and prop open the door.

## CHANGING COLOR PANELS

If you are redecorating, you can change your dishwasher's front panels to match or blend with your new colors.

Two panels are held in place by the door trim and the trim on the panel below the door. Each side of each panel is a different color. Or you can paint a panel with the color of your own choice.

**How to change the door panel inserts:**

1. Take out the three trim screws on either side of the dishwasher door. Remove the side trim.
2. Slide out both of the insert panels at once.
3. Put the panel with the color you want in front. (Handle the panels carefully. Edges may be sharp.)
4. Replace the side trim and screws.

**How to change the lower panel inserts:**

1. Remove the four panel attachment screws. (Two above panel, two below.)
2. Remove the entire panel.
3. Take out the three screws and remove the top trim.
4. Slide out both of the insert panels at once.
5. Replace the panels with the color you want in front.
6. Replace the top trim and screws.
7. Replace the entire panel and four attachment screws.

Color insert panels for the door and panel can be replaced by  $\frac{1}{4}$ " thick wood inserts to match your kitchen cabinets. Get them from your nearest cabinet dealer.

Dimensions for  $\frac{1}{4}$ " wood inserts:

Door Panel:  $18\frac{1}{4}$ " H  $\times$   $23\frac{1}{2}$ " W.

Lower Panel:  $4\frac{11}{16}$ " H  $\times$   $23\frac{1}{2}$ " W.

**Note: Do not operate the dishwasher while changing the panels or when the lower access panel is removed. When installing wood panels, you may need to check with your dealer for advice and/or assistance.**

# THE PROBLEM SOLVER

Check the Problem Solver Chart if you have a problem. It may be something minor you can correct. Simply locate your problem on the chart and follow the suggested remedy.

PROBLEM	POSSIBLE CAUSE AND REMEDY
DISHWASHER WON'T RUN	<ul style="list-style-type: none"> <li>• A fuse in your home may be blown or the circuit breaker tripped. Replace fuse or reset circuit breaker. Remove any other appliances from the circuit.</li> <li>• Be sure the door is tightly closed and latched.</li> </ul>
UNUSUAL NOISE	<ul style="list-style-type: none"> <li>• Make sure everything is securely placed in the dishwasher. Water may cause utensils to rattle.</li> <li>• Something small may have dropped from the rack.</li> <li>• Wash arm may be hitting an item when rotating. Load the items so nothing blocks the wash arms.</li> <li>• Chopping noises may be heard during the cycle due to the built-in disposer. This is normal.</li> </ul>
DISHES DON'T DRY	<ul style="list-style-type: none"> <li>• Check the rinse aid dispenser to see that it's not empty. (See page 5.)</li> <li>• Select the Drying Heat option.</li> <li>• Make sure the inlet water temperature is correct. (See page 4.)</li> <li>• Check for improper loading. Dishes shouldn't nest together. Avoid overloading.</li> <li>• Unload the bottom rack first. Water from dishes in the top rack may be spilling into the bottom rack.</li> <li>• Plastic items have a porous surface and tend to hold water. Towel drying may be required.</li> <li>• Glasses, cups, etc., with concave bottoms will hold water.</li> </ul>
UNCLEAN DISHES AND FLATWARE	<ul style="list-style-type: none"> <li>• Check the inlet water temperature. 140°F water is recommended. (To test, see page 4.)</li> <li>• Select the Water Heat option if available.</li> <li>• Use the amount of detergent recommended for your water hardness and be sure it is placed in the detergent dispenser properly. (See page 4.)</li> <li>• Select the proper cycle for soil level of dishload. (See page 1.)</li> <li>• Load the rack correctly. (See pages 5-7.)</li> </ul>
DETERGENT LEFT IN DISPENSER CUPS	<ul style="list-style-type: none"> <li>• The dispenser cover may not be opening or may be blocked by improperly loaded items. Move any dishes that may be blocking the detergent cup. If you used a powder detergent, open the cup and remove any caked-on detergent. If the cup still doesn't open automatically, call for service.</li> <li>• Detergent may be old. If the powder detergent is hard or caked in the box, throw it away. Be sure to store detergent in a cool, dry place.</li> <li>• The detergent may not be working well. Try another brand.</li> </ul>

*Continued on next page*

<b>PROBLEM</b>	<b>POSSIBLE CAUSE AND REMEDY</b>
SPOTS AND FILM ON GLASSES AND FLATWARE	<p>Spotting can be caused by all these things:</p> <ul style="list-style-type: none"> <li>• Extremely hard water. (See page 4.)</li> <li>• Low inlet water temperature. (To test, see page 4.)</li> <li>• Overloading the dishwasher.</li> <li>• Improper loading. (See pages 5-7.)</li> <li>• Old or damp powder detergent.</li> <li>• Rinse aid dispenser empty. (See page 5.)</li> <li>• Too little detergent. (See page 4.)</li> </ul> <p>Due to the varying local water conditions and personal preferences, try several brands of detergents to find one that gives the best results for you.</p> <p><b>To remove the spots and film from glassware:</b></p> <ol style="list-style-type: none"> <li>1. Remove all metal utensils from the dishwasher.</li> <li>2. DO NOT ADD DETERGENT.</li> <li>3. Select the NORMAL WASH cycle.</li> <li>4. Start the dishwasher and allow to run for approximately 20 minutes. The dishwasher will now be in the main wash.</li> <li>5. Then open the door and pour 1/2 cup (125 ml) of white vinegar into the bottom of the dishwasher.</li> <li>6. Close the door and allow the dishwasher to complete the cycle.</li> </ol> <p>Using a vinegar rinse more than twice a month? Consider a home water softener.</p>
CLOUDY GLASSWARE	<p>If vinegar doesn't remove the cloudiness, it is "etching." The film is permanent.</p> <p><b>To Prevent:</b></p> <ol style="list-style-type: none"> <li>1. Use less detergent if you have soft water. (See Detergent Usage Guide, page 4.)</li> <li>2. Wash glassware in the shortest cycle that will get them clean.</li> <li>3. Avoid manually pre-rinsing the dishes.</li> <li>4. Lower the temperature of water entering the dishwasher to 140°F. (See page 4.)</li> </ol>
STAINS OR MARKS ON DISHES OR TUB	<ul style="list-style-type: none"> <li>• Tea or coffee can stain cups. Remove the stains by hand, using a solution of 1/2 cup bleach and 3 cups warm water.</li> <li>• An overall yellow or brown film on dishes or glassware can be caused by iron deposits in the water. A special filter in the water supply line is the only way to correct this problem. Your water softener company can tell you about the filter. A product such as Rover Rust Remover® will usually remove the stains.</li> <li>• Yellow film on sterling silver results when you wash copper utensils in the same load. Silver polish will usually remove this stain.</li> <li>• Aluminum deposits often leave marks when they rub against other things. Remove the marks with a mild abrasive cleanser.</li> </ul>
DISHES CHIPPED	<ul style="list-style-type: none"> <li>• Rough handling can cause chipping. Load with care. Make sure glassware and china are secure and can't jar loose. (See page 6 for the correct way to load glassware.) Make sure tall glasses and stemware will clear the top of the tub when you push the rack into the dishwasher.</li> <li>• Refer to the chart on page 8 for suggested items that can and cannot be washed.</li> </ul>

Continued on next page

<b>PROBLEM</b>	<b>POSSIBLE CAUSE AND REMEDY</b>
DISHWASHER WON'T DRAIN	<ul style="list-style-type: none"> <li>• If the entire bottom of the tub has water, you may have a drain problem.</li> <li>• Check the kitchen sink. Is it draining well? You may need a plumber.</li> <li>• Check the drain hose for any kinks.</li> <li>• If dishwasher drains into a disposer, run the disposer to clear any debris.</li> </ul>
SUDS IN THE TUB	<ul style="list-style-type: none"> <li>• Sudsing detergents are not meant for dishwashers. <b>USE ONLY AUTOMATIC DISHWASHER DETERGENTS TO AVOID SUDSING.</b></li> <li>• <b>To remove suds from the tub:</b> <ol style="list-style-type: none"> <li>1. Open the dishwasher.</li> <li>2. Sprinkle 1 cup of salt on top of the suds to help evaporate them.</li> <li>3. Add 1 gallon of cold water to the tub.</li> <li>4. Close and latch the dishwasher.</li> <li>5. Pump out water by slowly turning the control dial until a drain period is reached or select the drain pad.</li> <li>6. Repeat if necessary.</li> </ol> </li> </ul>
DISHWASHER LEAKS	<ul style="list-style-type: none"> <li>• Suds can cause the dishwasher to overflow. Use a detergent that's designed especially for automatic dishwashers.</li> <li>• Spilling the rinse aid can cause foam during washing. This can lead to overflowing. Wipe up accidental spills of rinse aid with a damp cloth.</li> </ul>
ODOR	<ul style="list-style-type: none"> <li>• Dishwashers will have a "new" smell when installed. This will decrease with time. (See page 9 for further suggestions.)</li> <li>• Soiled dishes held too long. Use the Rinse &amp; Hold, if available.</li> <li>• Dishwasher not draining properly. (See Dishwasher Won't Drain.)</li> </ul>

## IF YOU NEED SERVICE

For the nearest service outlet, contact the dealer or consult the telephone directory Yellow Pages under Dishwashing Machines.

For additional information about your dishwasher, write to the manufacturer. Be sure to include the model and serial numbers shown on the serial plate located just inside the door.

**If you are dissatisfied with the service you received, here are three steps you should follow:**

**FIRST**, contact the people who serviced your appliance. Explain why you are not pleased. In most cases, this will solve the problem.

**NEXT**, if you are still dissatisfied, write all the details—including your phone number—to:

Maycor Service Department  
 240 Edwards Street  
 Cleveland, TN 37311  
 Phone 615-472-3500

**FINALLY**, if your problem is still not resolved, write:

Major Appliance Consumer Action Panel  
 20 North Wacker Drive  
 Chicago, Illinois 60606

This panel, known as MACAP, is a group of independent consumer experts under the sponsorship of several industry associations. Its purpose is to study practices and advise the industry of ways to improve customer service. Because MACAP is free of industry control and influence, it is able to make impartial recommendations and consider each case individually.

# **Full One-Year Warranty For Dishwasher**

The manufacturer will repair or replace, without charge, any part of your product which has a defect in material or workmanship during the first year after the date of the original installation.

## **Limited Ten-Year Warranty**

For ten years from date of original purchase, we will provide, free of charge, parts and service labor to repair or replace the DURA™ 10 tub or door liner if it fails to contain water because of a manufacturing defect such as cracking or peeling.

You are responsible for the service technician's travel charges beyond the normal service area, local cartage, and normal maintenance.

## **What is Not Covered by this Warranty**

1. Conditions and damage resulting from improper installation, delivery, unauthorized repair, modification, or damage not attributable to a defect in material or workmanship.
2. Conditions resulting from damage, such as: (a) improper maintenance, (b) misuse, abuse, accident, alteration, or (c) incorrect electrical current or voltage.
3. Warranty is void if the original serial number has been removed, altered or cannot be readily determined.
4. Any product used for other than normal household use. It does not extend to products purchased for commercial or industrial use.
5. Any expense incurred for service calls to correct installation errors or to instruct you on how to use the product.
6. CONSEQUENTIAL OR INCIDENTAL DAMAGES SUSTAINED BY ANY PERSON AS A RESULT OF ANY BREAK OF THIS WARRANTY OR ANY IMPLIED WARRANTY. Some states do not allow the exclusion or limitation of consequential or incidental damages, so the above exclusion may not apply to you.

## **How to Obtain Service**

To obtain the repair or replacement of a defective part under this warranty, you should contact the dealer or builder from whom you purchased the appliance or a service agent he designates.

## **Additional Help**

If you are not satisfied with the local response to your service requirements and wish to contact the manufacturer, please address your letter to Maycor Parts & Service Co., 240 Edwards St. SE, Cleveland, Tennessee 37311 or call 615-472-3500. To save time, your letter should include the complete model and serial number of the warranted appliance, the name and address of the dealer from whom you purchased the appliance, the date of purchase, and details concerning your problem.

This warranty is the only written or expressed warranty given by the manufacturer. No one is authorized to increase, alter, or enlarge responsibility or obligations under this warranty. This warranty gives you specific legal rights, and you may also have other rights which vary from state to state.

Consult the Yellow Pages of your telephone directory under DISHWASHING MACHINES for the service source nearest you.

---

**NOTES:**

---

**NOTES:**